

Operating and mounting instructions

Piazza 2 / 4 / 6 / 8 (RGB)-T

Order No.: 81211-xx and 81213-xx

General usage

KNX control panels of the IPAS Piazza-T product range can be used for all standard switch and configuration functions via the KNX bus. The functions switching, dimming, value setting, blinds and sun protection, fan levels, and much more can be implemented with 2, 4, 6 and 8 buttons.



Front view Piazza 8 RGB-T

Individually printed labels can be inserted into a description field so that functions can be clearly assigned to the buttons. All devices have two orientation/status LEDs which can be illuminated in different RGB colours. These are located at the top and bottom of the description field in the central part of the panel.

In addition, Piazza devices from the Piazza 2 / 4 / 6 / 8 RGB-T range offer one status LED per button. Again these are RGB LEDs which can be illuminated in different colours. An external temperature sensor can be connected to the devices to measure the room temperature. The measured value becomes available as an object on the KNX bus.

The KNX bus coupler is directly integrated into the device. A standard bus terminal is used for the connection. In addition, the devices offer an integrated magnet sensor which allows for an already mounted device to be changed into programming mode. The magnet is available as an optional extra.

The control panels can be mounted onto all standard flush-mounting boxes of Ø 55mm via two mounting screws. They can be combined with 55mm socket frames programs from various manufacturers. It is also possible to have several Piazza pushbuttons within a frame combination.

Device types and accessories

The following Piazza devices and accessories are available:

Product	Description	Order-No.
Piazza 2 RGB-T	Control panel	81213-02
Piazza 4 RGB-T	Control panel	81213-04
Piazza 6 RGB-T	Control panel	81213-06
Piazza 8 RGB-T	Control panel	81213-08
Piazza 4-T	Control panel	81211-02
Piazza 6-T	Control panel	81213-04
Piazza 8-T	Control panel	81213-06
Piazza 4-T	Control panel	81213-08
NTC Sensor	Accessories	81271-00
Programming magnet	Accessories	81987-00

Scope of delivery

The following individual components are part of the Piazza delivery package:

- Complete device with plugged in bus connector (KNX)
- Operating and mounting instructions
- Delivery in unbreakable individual packaging

A frame is not included in the scope of delivery.

Application program

The following application program is currently available for the Piazza control panel:

ETS_8121x_PiazzaT_V1.0.0.knxprod

Installation advice



Danger to life from electric current.

- The device must only be installed and commissioned by an accredited electrical engineer.
- Please follow country-specific safety and accident prevention rules!
- The device is intended for interior installation in dry rooms.
- For the installation, the device must be switched to zero potential.
- Do not open the device! Faulty devices must be returned to the manufacturer.
- Please follow country-specific rules and regulations for the planning and construction of electrical installations.

Technical data

CONNECTION DATA		
Power supply	Supply Voltage: Consumption:	via KNX Bus 24V/40mA (approx. 1W)
Connectors	KNX: (black/red) Connection plug:	0,6...0,8mm solid, TP NTC-Sensor
Temperature sensor	Type: Range:	NTC-Sensor 5...45°C
GENERAL DATA		
Control and display elements	KNX function keys: Programming button: 1 LED, red: 2 LEDs, rgb: 2/8 LED, rgb:	Depending on the model, 2, 4, 6 or 8 buttons. To assign the physical address. Displays addressing mode. Orientation lights at the top and bottom of the description field. Depends on the model Status LEDs on each button.
Mechanical data (Depending on the model)	Casing: Width: Height: Length: Weight: Mounting:	Casing: Plastic ABS - PC 70 mm 37 mm 70 mm 55 g Clamped in the cutout or using a universal wall box.
Electrical safety	Pollution class: Protection type:*\br/>Protection class:** Overvoltage category: KNX Bus:	2 IP20 III III SELV DC 30V
EMC requirements	Complies with:	EMC directive 2014/30/EU
Environmental conditions	Weather resistance: Environmental conditions in operation: Storage temperature: Transportation temperature: Rel. humidity: (non condensing)	EN 50090-2-2 -5°C to +45°C -25°C to +55°C -25°C to +70°C 5 % to 93 %
Approbation and CE-Signage	KNX registered: According to EMC-Guidelines:	No (Residential and commercial buildings), Low Voltage guidelines.

* (according to EN 60529); ** (according to IEC 1140)

Location and function of the display and control elements

Control elements:

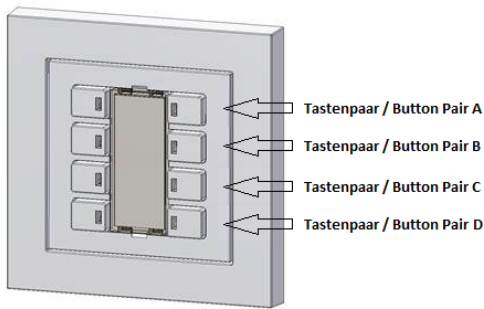

Display elements:

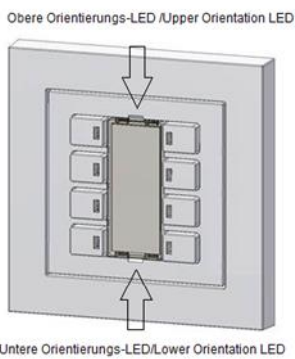

Programming button and programming LED:

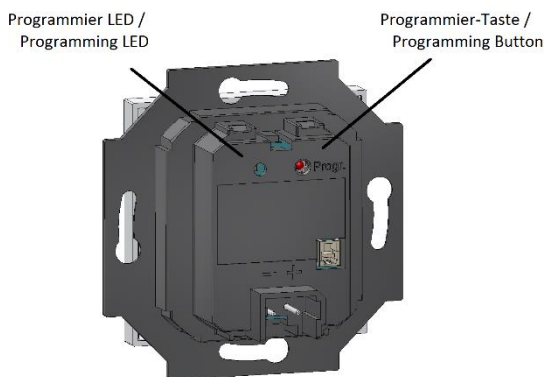

Area to activate addressing mode via magnet

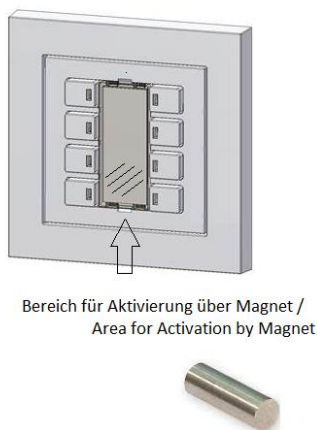

Connecting external temperature sensors

An NTC temperature sensor with a 1-m connecting cable and connector plug is available for the device as an optional extra.



The sensor is plugged into the socket on the back of the device. The locking catch must audibly engage when you plug it in.

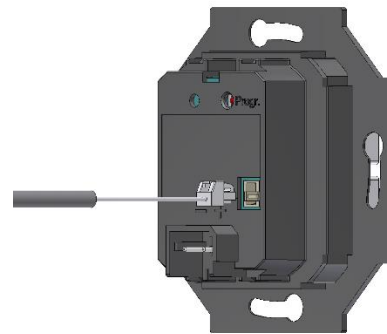

To dismount a connected plug, please press down the lever on the locking catch.

Mounting

Step 1: Before the device is mounted onto a flush-mounting box, the bus cable has to be connected to the bus terminal and plugged into the rear of the device. Please remember to now assign the physical address of the KNX participant. Once the device has been mounted, the programming button and programming LED that are needed to assign the address are no longer accessible.

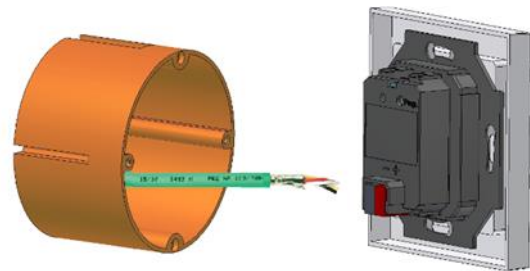

Step 2: The device is directly mounted onto a flush-mounting box. Use the erection screws to fix the Piazza buttons to the box.

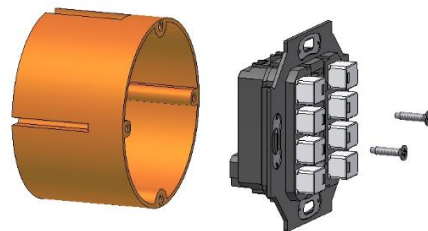

Step 3: Place a standard frame for 55mm panels (not part of the delivery package) on top.

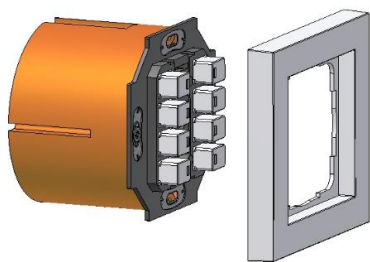

Step 4: The central panel is placed on top of the buttons and attached with the enclosed screw.

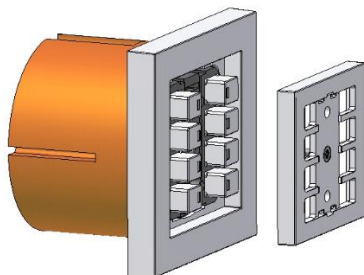

Step 5: If any labels have been printed, they are inserted into the description field and the window is placed on top.

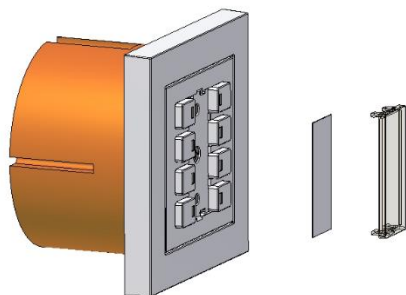

Step 6: Once the device has been mounted, you can load the application program and operate the buttons.

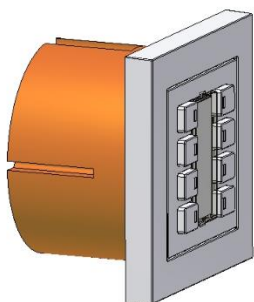

Demounting

Step 1: To demount the device, you need to remove the window first. Please use an appropriate tool to carefully loosen it and take it off the buttons.

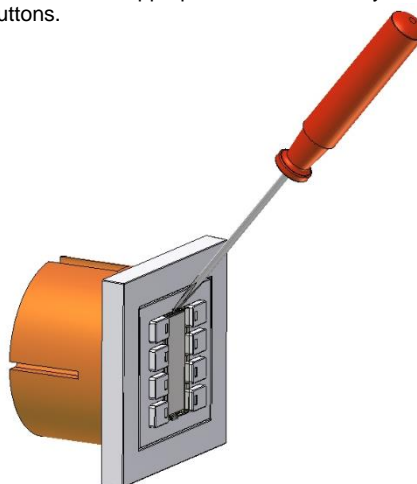

Step 2: Once the window has been removed, you can demount the device using the same steps as above in reverse.

