

FEATURES

- 2 constant voltage configurable channels (combinable independent channels and TW channel)
- 1 relay to control the LEDs power supply or for independent use
- Supports KNX Data Secure
- Master Light control
- External 12-40 VDC power supply
- Manual output operation with push button and LED status indicator
- Total data saving on KNX bus failure
- Integrated KNX BCU (TP1-256)
- Dimensions 137.4 x 55 x 30.5 mm
- Surface-mounted inside panels, distribution boxes or false ceiling
- Conformity with the CE, RCM directives (marks on the right side)

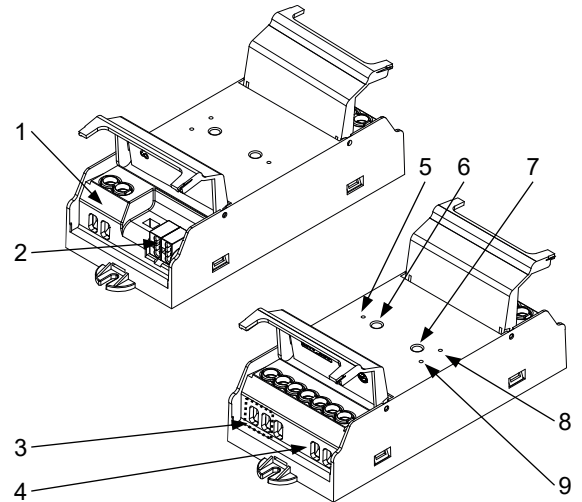

Figure 1: Lumento X2 v2

1. Power Supply Relay	2. KNX connector	3. External power supply	4. Output channels	5. Programming LED
6. Programming button	7. Test button	8. Power supply LED	9. Error notification LED	

PROGRAMMING BUTTON: short press to set programming mode. If this button is held while plugging the device into the KNX bus, it enters the safe mode. In order to perform a KNX Secure factory reset, while the device is in safe mode, press the button for 10 seconds until the programming LED changes its state.

TEST BUTTON: short press changes sequently each channel to 100%. A long press regulates the active channel.

PROGRAMMING LED: programming mode indicator (red). When the device enters the safe mode, it blinks (red) every half second. During the start-up (reset or after KNX bus failure) and if the device is not in safe mode, it emits a red flash. The Test-On mode is indicated through green color.

GENERAL SPECIFICATIONS

CONCEPT		DESCRIPTION		
Type of device		Electric operation control device		
KNX supply	Voltage (typical)	29 VDC SELV		
	Voltage range	21-31 VDC		
	Maximum consumption	Voltage	mA	mW
		29 VDC (typical)	4.9	142.1
24 VDC ¹	10	240		
Connection type		Typical TP1 bus connector for 0.8 mm Ø rigid cable		
External power supply		12-40 VDC		
Operation temperature		0 .. +55 °C		
Storage temperature		-20 .. +55 °C		
Operation humidity		5 .. 95%		
Storage humidity		5 .. 95%		
Complementary characteristics		Class B		
Protection class / Overvoltage category		- / III (4000 V)		
Operation type		Continuous operation		
Device action type		Type 1		
Electrical stress period		Long		
Degree of protection		IP20, clean environment		
Installation		Independent device to be surface-mounted inside electrical panels or boxes. The installation is also possible in false ceiling.		
Minimum clearances		Not required		
Response on KNX bus failure		Data saving according to parameterization		
Response on KNX bus restart		Data recovery according to parameterization		
Operation indicator		The programming LED indicates programming mode (red) and test mode (green). The error LED notifies the existence of an error.		
Weight		134 g		
PCB CTI index		175 V		
Housing material		PC FR V0 halogen free		

¹ Maximum consumption in the worst-case scenario (KNX Fan-In model).

OUTPUTS SPECIFICATIONS AND CONNECTIONS	
CONCEPT	DESCRIPTION
Number of outputs	2
Output type / Disconnection type	Solid state switching device
Maximum load per output	8 A
Total maximum current in device	16 A
Load type	LED strip (monochrome, RGB, RGBW or TW) with common anode (+)
Short-circuit protection	YES
Overheating protection	YES
Connection method	Screw terminal block (0.5 Nm max.)
Cable cross-section	1.5-4 mm ² (IEC) / 26-10 AWG (UL)

EXTERNAL POWER SUPPLY SPECIFICATIONS AND CONNECTIONS	
CONCEPT	DESCRIPTION
Voltage	12-40 VDC (voltage in concordance with voltage LED strips to be connected)
Current	Depending upon the load to be controlled up to a maximum of 20 A
Connection method	Screw terminal block (0.5 Nm max.)
Cable cross-section	1.5-4 mm ² (IEC) / 26-10 AWG (UL)

RELAY SPECIFICATIONS AND CONNECTIONS		
CONCEPT	DESCRIPTION	
Number of outputs	1	
Output type / Disconnection type	Potential-free outputs through bistable relays with tungsten pre-contact / micro-interruption	
Relay rated current	AC 16(6) A @ 250 VAC (4000 VA) DC 7 A @ 30 VDC (210 W)	
Maximum load per output	Resistive	4000 W
	Inductive	1500 VA
Maximum inrush current	800 A/200 μs 165 A/20 ms	
Short-circuit protection	NO	
Overload protection	NO	
Connection method	Screw terminal block (0.5 Nm max.)	
Cable cross-section	1.5-4 mm ² (IEC) / 26-10 AWG (UL)	
Maximum response time	10 ms	
Mechanical lifetime (min. cycles)	3 000 000	
Electrical lifetime (min. cycles)	100000 @ 8 A / 25000 @ 16 A (VAC)	

* If you parameterize channels in parallel, those parameterized channels in this way should be connected together through a bridge.

WIRING DIAGRAMS

INDEPENDENT CHANNELS

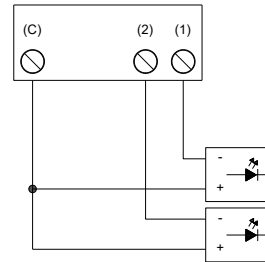

TW CHANNEL

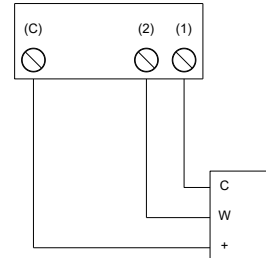

*PARALLEL CHANNELS

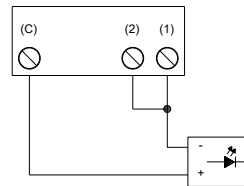

POWER SUPPLY RELAY

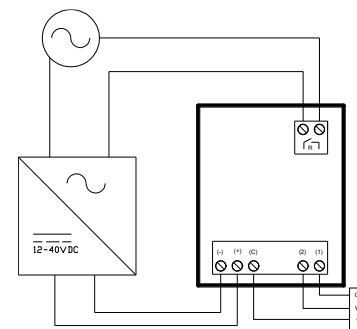

DIMENSIONS (mm)

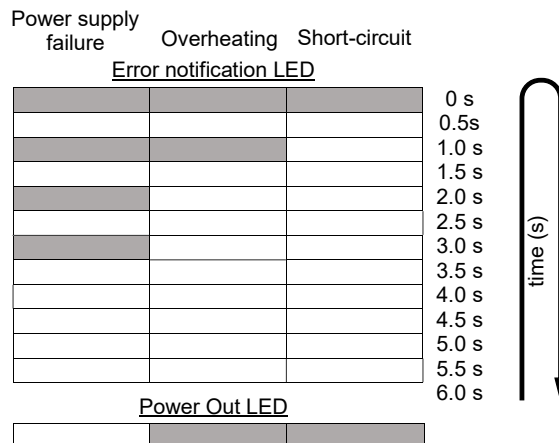
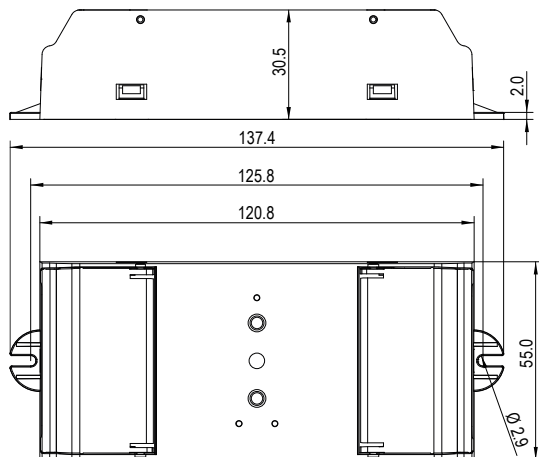

Figure 2: Error notification LED codes

SAFETY INSTRUCTIONS AND ADDITIONAL NOTES

- Installation should only be performed by qualified professionals according to the laws and regulations applicable in each country.
- Do not connect the mains voltage nor any other external voltage to any point of the KNX bus; it would represent a risk for the entire KNX system. The facility must have enough insulation between the mains (or auxiliary) voltage and the KNX bus or the wires of other accessories, in case of being installed.
- The home automation facility must be equipped with a device that ensures the omnipolar sectioning. Installation of a 16 A mini-circuit-breaker is recommended. To prevent accidents, it must remain open in case of manipulation of the device.
- Once the device is installed (in the panel or box), it must not be accessible from outside.
- Keep the device away from water (condensation over the device included) and do not cover it with clothes, paper or any other material while in use.
- The WEEE logo means that this device contains electronic parts and it must be properly disposed of by following the instructions at <https://www.zennio.com/en/legal/weee-regulation>.
- This device contains software subject to specific licences. For details, please refer to <https://zennio.com/licenses>.